



# Binks MACH 1, Mach 1V, HVLP Spray Gun

## MACH 1 With Adjustable Fluid Inlet 6202-XXXX-X

The Binks MACH 1 HVLP gun is a top quality high performance air spray gun. You only have to pick it up to feel the difference. Its superbly balanced forged aluminum body offers the operator extra comfort and control. All of the gun's components are machined and finished to exacting tolerances and only the best materials are used, ensuring years of peak efficiency.

The MACH 1 HVLP airspray gun has special nozzles and modifications that allow it to operate at high transfer efficiencies in compliance with the "California South Coast Air Quality Management District" regulations as a "high volume, low pressure" airspray gun.

The air inlet passage in the gun body incorporates a venturi which limits airflow. High pressure, low volume airflow is converted to high volume, low pressure at this point. Special air and fluid nozzles enable the gun to atomize fluid at low air pressures and velocities, creating the "soft spray" effect for high transfer efficiencies.

To obtain optimum performance from your new MACH 1 HVLP airspray gun, read all instructions carefully.

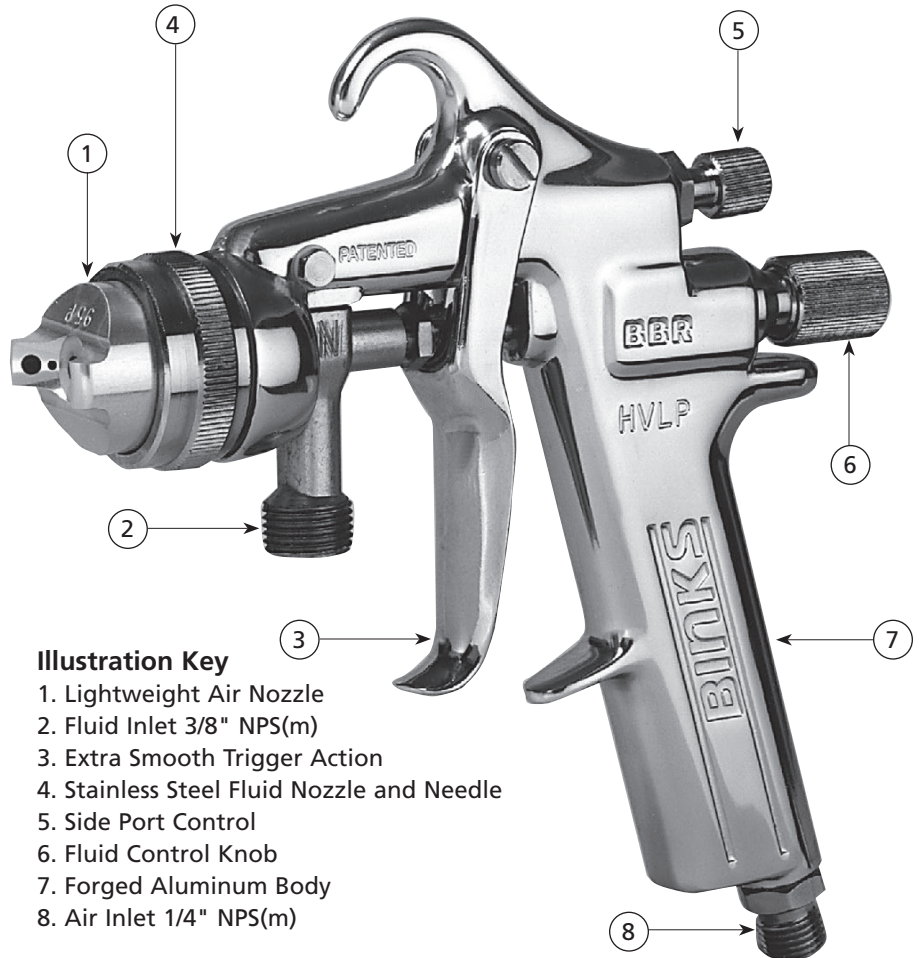

### Illustration Key

1. Lightweight Air Nozzle
2. Fluid Inlet 3/8" NPS(m)
3. Extra Smooth Trigger Action
4. Stainless Steel Fluid Nozzle and Needle
5. Side Port Control
6. Fluid Control Knob
7. Forged Aluminum Body
8. Air Inlet 1/4" NPS(m)

### Package Contents

Please note that your Binks MACH 1 HVLP airspray gun package was shipped with the following contents. If anything in the following list is missing, call 1-800-992-4657 for a prompt shipment to you of the missing item.

- 1 MACH 1 Spray Gun
- 1 Part Sheet . . . . . 77-2463
- 1 Gunners Mate
- 1 Gun Brush
- 1 Cleaning Brush

### IMPORTANT REGULATORY NOTE

Some regulatory agencies prohibit the operation of HVLP spray guns above 10 psi nozzle atomizing pressure. Users subject to this type of regulation should not exceed 10 psi (50 psi gun inlet pressure). See Air Pressure Recommendations, page 7 and General Spray Instructions, page 5. It is recommended that the nozzle test gauge (see below) be used to confirm actual nozzle operating pressure.

It may also be a requirement of some regulatory agencies that users have this gauge nozzle available on site to verify that the gun is being operated within the limits of applicable rules.

Replaces Part Sheet 77-2463R-17	Part Sheet 77-2463R-18
---------------------------------------	------------------------------

In this part sheet, the words **WARNING**, **CAUTION** and **NOTE** are used to emphasize important safety information as follows:

**⚠ WARNING**  
 Hazards or unsafe practices which could result in severe personal injury, death or substantial property damage.

**⚠ CAUTION**  
 Hazards or unsafe practices which could result in minor personal injury, product or property damage.

**NOTE**  
 Important installation, operation or maintenance information.

**⚠ WARNING**

Read the following warnings before using this equipment.



**READ THE MANUAL**  
 Before operating finishing equipment, read and understand all safety, operation and maintenance information provided in the operation manual.



**WEAR SAFETY GLASSES**  
 Failure to wear safety glasses with side shields could result in serious eye injury or blindness.

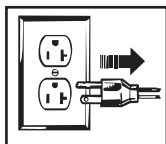

**DE-ENERGIZE, DISCONNECT AND LOCK OUT ALL POWER SOURCES DURING MAINTENANCE**  
 Failure to De-energize, disconnect and lock out all power supplies before performing equipment maintenance could cause serious injury or death.



**OPERATOR TRAINING**  
 All personnel must be trained before operating finishing equipment.



**EQUIPMENT MISUSE HAZARD**  
 Equipment misuse can cause the equipment to rupture, malfunction, or start unexpectedly and result in serious injury.



**KEEP EQUIPMENT GUARDS IN PLACE**  
 Do not operate the equipment if the safety devices have been removed.

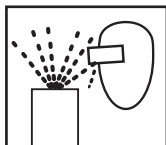

**PROJECTILE HAZARD**  
 You may be injured by venting liquids or gases that are released under pressure, or flying debris.



**PINCH POINT HAZARD**  
 Moving parts can crush and cut. Pinch points are basically any areas where there are moving parts.



**AUTOMATIC EQUIPMENT**  
 Automatic equipment may start suddenly without warning.



**INSPECT THE EQUIPMENT DAILY**  
 Inspect the equipment for worn or broken parts on a daily basis. Do not operate the equipment if you are uncertain about its condition.



**NEVER MODIFY THE EQUIPMENT**  
 Do not modify the equipment unless the manufacturer provides written approval.



**KNOW WHERE AND HOW TO SHUT OFF THE EQUIPMENT IN CASE OF AN EMERGENCY**



**PRESSURE RELIEF PROCEDURE**  
 Always follow the pressure relief procedure in the equipment instruction manual.



**NOISE HAZARD**  
 You may be injured by loud noise. Hearing protection may be required when using this equipment.



**STATIC CHARGE**  
 Fluid may develop a static charge that must be dissipated through proper grounding of the equipment, objects to be sprayed and all other electrically conductive objects in the dispensing area. Improper grounding or sparks can cause a hazardous condition and result in fire, explosion or electric shock and other serious injury.

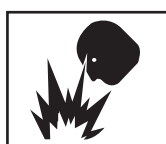

**FIRE AND EXPLOSION HAZARD**  
 Never use 1,1,1-trichloroethane, methylene chloride, other halogenated hydrocarbon solvents or fluids containing such solvents in equipment with aluminum wetted parts. Such use could result in a serious chemical reaction, with the possibility of explosion. Consult your fluid suppliers to ensure that the fluids being used are compatible with aluminum parts.



**PROP 65 WARNING**  
 WARNING: This product contains chemicals known to the State of California to cause cancer and birth defects or other reproductive harm.

IT IS THE RESPONSIBILITY OF THE EMPLOYER TO PROVIDE THIS INFORMATION TO THE OPERATOR OF THE EQUIPMENT.

FOR FURTHER SAFETY INFORMATION REGARDING BINKS AND DEVILBISS EQUIPMENT,  
 SEE THE GENERAL EQUIPMENT SAFETY BOOKLET (77-5300).

**TYPES OF INSTALLATION**

**CONNECTING GUN TO "PRESSURE ASSISTED" 1 QT. CUP (Figure 1)**

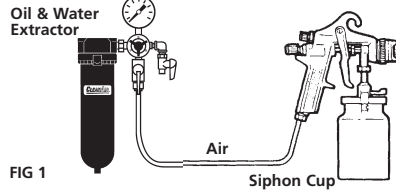

FIG 1

The stainless steel pressure-assisted 1 quart cup utilizes a low pressure air bleed port on the gun head to slightly pressurize the cup and provide fluid flow to the nozzle. A check valve prevents the cup from depressurizing when the gun trigger is released and airflow stops.

To connect the gun to the cup, remove the plug (22) in the gun head and install the hose barb fitting provided with cup assembly. Attach cup assembly to 3/8" NPS fluid inlet connection and firmly tighten. The siphon tube should be angled toward the front of the gun, i.e. under the nozzles, and the pressure hose in the cup lid positioned to the left of the trigger. Connect check valve assembly hose from barb fitting on gun head to check valve inlet fitting on cup cover. Make sure the check valve is connected so the air comes from the gun, through the check valve, into the cup.

Air pressure for atomization is regulated at the extractor. The flow of the fluid is adjusted by the fluid valve control knob on gun, viscosity of paint and air pressure.

**PRESSURE CUP HOOKUP (Figure 2)**

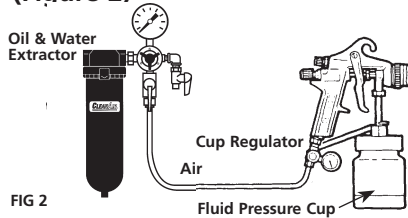

FIG 2

For fine finishing with limited spraying. Air pressure for atomization is regulated at extractor; fluid pressure at cup regulator. Pressure cup is also available less regulator.

**PRESSURE TANK HOOKUP**

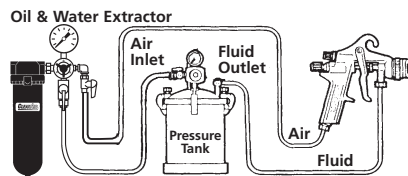

FIG 3

**(Figure 3)**

For medium production spraying (single regulator). Air pressure for atomization is

regulated at extractor, fluid pressure at tank regulator.

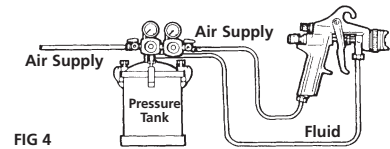

FIG 4

**PRESSURE TANK WITH 2 REGULATORS (Figure 4)**

The pressure to the tank is regulated by the first regulator. The pressure for atomization is regulated by the second regulator.

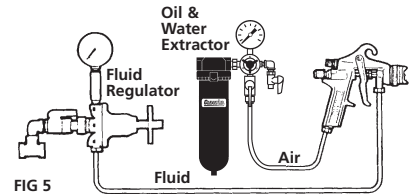

FIG 5

**PRESSURE CIRCULATING HOOKUP (Figure 5)**

For heavy production spraying. Air pressure atomization regulated at extractor. Fluid pressure regulated at fluid regulator.

**AIR PRESSURE**

Atomizing pressure must be set properly to allow for the drop in air pressure between the regulator and the spray gun.



Only 34 PSI at gun inlet  
25 feet of 1/4" I.D. hose causes a drop of 26 PSI between the air supply and the gun.

**(NOT RECOMMENDED)**

**With 60 psi applied at air supply**



Cross section view showing comparison of inside hose diameters (actual size). 60 lbs. regulated pressure

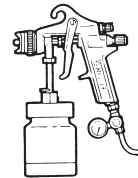

48 PSI at gun inlet  
25 feet of 5/16" I.D. hose causes a drop of 12 PSI between the air supply and the gun. For this reason Binks recommends the use of 5/16" hose.

**(RECOMMENDED)**

**Binks oil and water extractor is important.**

Achieving a fine spray finish without the use of a good oil and water extractor is virtually impossible.

A Binks regulator / extractor serves a double purpose. It eliminates blistering and spotting by keeping air free of oil and water, and it gives precise air pressure control at the gun.

Binks recommends using Model HFRL-508 Oil and Water Extractor / Regulator. See your local distributor for other models.

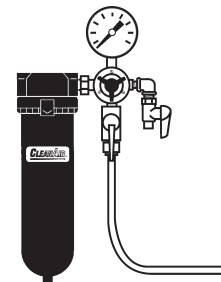

## OPERATION AND MAINTENANCE FOR MACH 1 HVLP SPRAY GUN

Your new MACH 1 HVLP spray gun is exceptionally rugged in construction and is built to stand up under hard, continuous use. However, like any other fine precision instrument, its most efficient operation depends on a knowledge of its construction, operation and maintenance. Properly handled and cared for, it will produce beautiful, uniform finishing results long after other spray guns have worn out.

### SET-UP FOR SPRAYING

#### Connecting Gun To Air Hose

Air should be supplied by a suitable length of 5/16" diameter air hose fitted with a 1/4" NPS(f) connection at gun end. For hose lengths over 50', use 3/8" diameter hose.

#### Connecting Gun To Fluid Hose

Fluid should be supplied by a suitable length of 3/8" diameter fluid hose fitted with a 3/8" NPS(f) connection at gun end. 1/4" diameter hose is recommended for use with low viscosity fluids. (Fluid hoses of different composition are available for special fluids.)

### SPRAY GUN CLEANING INSTRUCTIONS

In certain states it is now against the law to spray solvents containing Volatile Organic Compounds (VOC)'s into the atmosphere when cleaning a spray gun.

In order to comply with these air quality laws Binks recommends one of the following two methods to clean your spray finishing equipment:

1. Spray solvent through the gun into a closed system. An enclosed unit or spray gun cleaning station condenses solvent vapors back into liquid form which prevents escape of VOC's into the atmosphere.
2. Place spray gun in a washer type cleaner. This system must totally

enclose the spray gun, cups, nozzles and other parts during washing, rinsing and draining cycles. This type of unit must be able to flush solvent through the gun without releasing any VOC vapors into the atmosphere.

Additionally, open containers for storage or disposal of solvent or solvent-containing cloth or paper used for surface preparation and clean-up may not be used. All containers shall be nonabsorbent.

#### Pointers On Cleaning

When used with 1 quart cup, relieve pressure in the cup. Then unscrew, empty and carefully rinse cup out with thinners. Place clean thinners in the cup and spray this through the gun until it is clean. Blow air through gun to dry it.

#### When Used With Pressure Container

Shut off air supply to container and release the pressure on the container. Hold a piece of cloth wadded in the hand over the gun nozzle (3) and pull the trigger. The air will back up through the fluid nozzle and force the fluid out of the hose into the container. Empty container. Put enough thinner into the container to wash hose and gun thoroughly and spray this through the gun until it is clean. Then blow out the fluid hose to dry it and remove all traces of fluid by attaching it to the air line.

#### When used with Paint Circulating System

Shut off fluid supply and remove fluid hose from gun. Clean as gun used with siphon cup or pressure container or connect quick release on paint line solvent line. To ensure a clean air supply to your spray gun, use Binks oil and water extractor. See your Binks distributor for the correct model.

### GENERAL MAINTENANCE

#### To Replace Air Valve and Spindle Assembly

Remove fluid control knob (23), spring (18) and fluid needle (20). Unscrew housing (19) and remove spindle assembly (17) with springs (16 & 18), seal retainers (15) and o-rings (14). Lubricate new o-rings with *Gunners Mate*. Assemble components using fluid needle. Place this assembly along with housing (19) into gun body and screw into position. Remove fluid needle and tighten housing.

#### To Replace Needle Seal and Gland Adapter in Fluid Inlet

Remove fluid control knob (23) and spring (18) and pull out fluid needle (20). Unscrew packing nut (31) and remove spring (30) and seal backup (29). Using a no. 8 x 1-1/4 coarse thread wood screw (Binks part no. 20-6536) or a small sheet metal screw, remove the needle seal (28) and gland adapter (27). Replace gland adapter (27) and needle seal (28). Re-insert seal backup (29), spring (30) and screw on packing nut (31) a couple of turns so it fits loosely by hand. Reassemble fluid needle (20), spring (18) and fluid control knob (23). Finally, tighten packing nut (31) until it bottoms out on fluid inlet (26).

### **CAUTION**

All parts on a spray gun should be screwed in hand tight at first; this will avoid the possibility of cross threading the parts. If the parts cannot be turned by hand easily, make sure you have the correct parts, unscrew, realign, and try again. NEVER use undue force in mating parts.

## Binks MACH1, MACH 1 ADJUSTABLE FLUID INLET

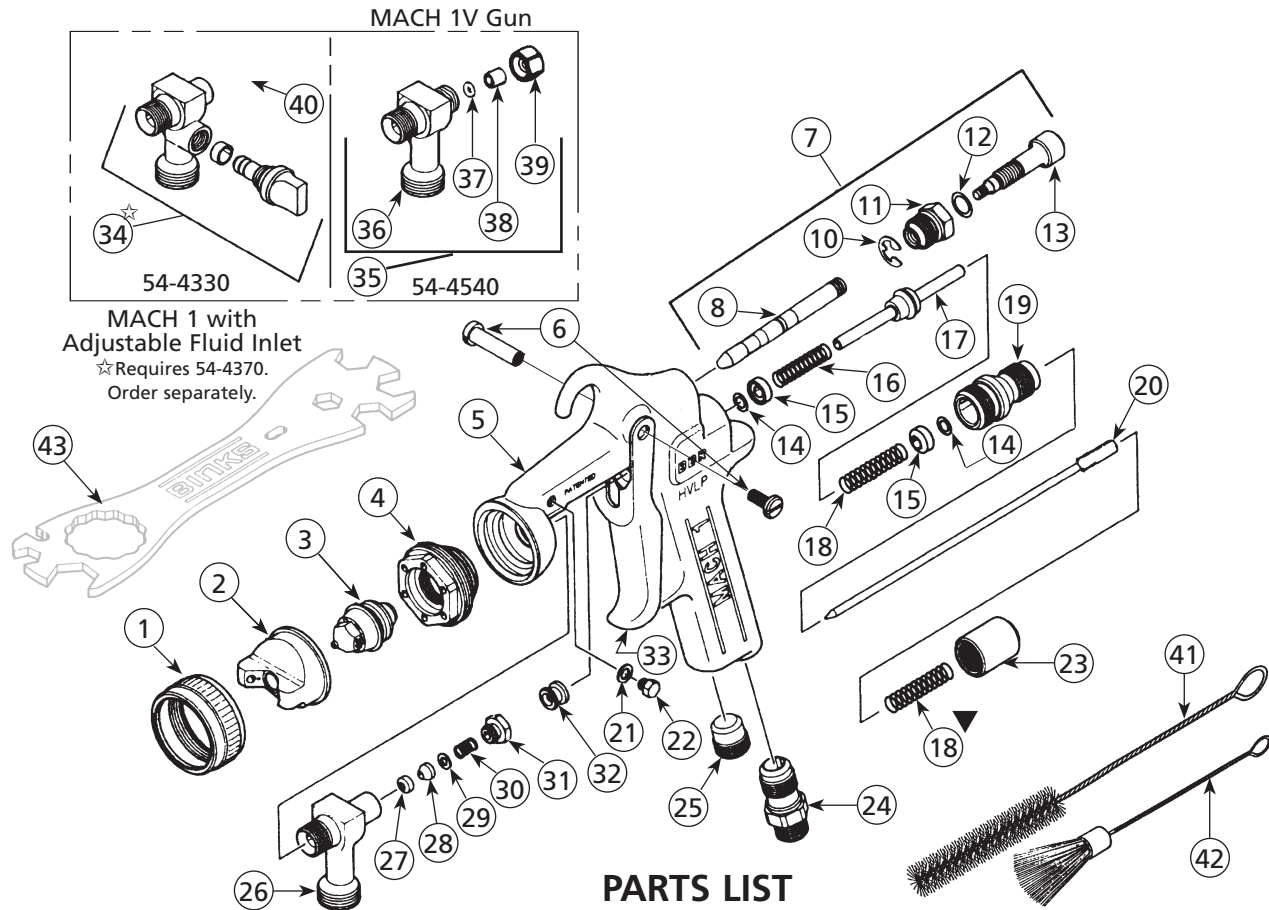

MACH 1 with Adjustable Fluid Inlet  
 ☆ Requires 54-4370.  
 Order separately.

### PARTS LIST

(When ordering, please specify Part No.)

ITEM NO.	PART NO.	DESCRIPTION	QTY.	ITEM NO.	PART NO.	DESCRIPTION	QTY.
1	54-3531□	RETAINING RING (Metal).....	1	25	54-3504	PLUG .....	1
2	*	AIR NOZZLE .....	1	26	54-3533	FLUID INLET (Stainless Steel) .....	1
3	*	FLUID NOZZLE .....	1	27	54-4264▲■◆	GLAND ADAPTER	
4	54-3543	HEAD INSERT.....	1	28	54-4265▲■◆	NEEDLE SEAL	
5	54-3922●	GUN BODY ASSEMBLY		29	54-4266▲■◆	SEAL BACKUP	
6	54-3919	TRIGGER STUD & SCREW KIT .....	1	30	54-4267▲■◆★	SPRING	
7	54-3946	SIDE PORT CONTROL ASSEMBLY #6.....	1	31	54-4263▲■◆	PACKING NUT	
8	54-3956★	CONTROL STEM.....	1	32	54-3513	VALVE SPINDLE CAP.....	1
10	54-3511★	RETAINING RING .....	1	33	54-3547	TRIGGER.....	1
11	54-4218★	CONTROL BODY.....	1	34	54-4330☆	ADJUSTABLE FLUID INLET (Optional)	
12	20-6160	O-RING.....	1	35	54-4540†	VITREOUS FLUID INLET ASSEMBLY....	1
13	54-4217★	CONTROL SCREW.....	1			(Optional)	
14	20-4615-5◆○	O-RING (PTFE).....	2	36	54-4541†★	VITREOUS FLUID INLET (Optional)....	1
15	54-3515	SEAL RETAINER.....	2	37	20-2227-5○†◆★	O-RING (Buna) (Optional) .....	1
16	54-3520◆	SPRING (Yellow).....	1	38	54-4531†◆★	PACKING SPACER (Optional) .....	1
17	54-3512◆	SPINDLE ASSEMBLY.....	1	39	54-4542†★	NUT ASSEMBLY (Optional) .....	1
18	54-3518▼◆	SPRING (Blue) .....	2	40	54-4370	SEAL CARTRIDGE ASSEMBLY	
19	54-3541	HOUSING .....	1			for Adjustable Fluid Inlet (Not Included)	
20	*■	FLUID NEEDLE (Stainless Steel) .....	1	41	82-469	GUN BRUSH .....	1
21	54-3925★	GASKET.....	1	42	82-221	CLEANING BRUSH .....	1
22	54-3928★	PLUG .....	1	43	54-3918	WRENCH (Optional, Not Included)	
23	54-3606	FLUID CONTROL KNOB.....	1		6-428	GUNNERS MATE (Not Shown) .....	1
24	54-768	AIR CONNECTION.....	1			(20 ea. 2 oz. bottles)	

\* Select from Air Fluid Nozzle chart, page 6.

\*\* For special purpose nozzles see chart, page 6.

▼ Optional 54-4427 Heavy Duty Spring .....

▲ Part of Self-Adjusting Packing Kit (54-4261) without needle.  
 ■ Part of Self-Adjusting Packing Kit (54-4262) with 54-3941 needle.

● Item NOT available separately.

†MACH 1V with vitreous set-up. Optional. Order 54-4540.

□ Optional 54-4318 Plastic Retaining Ring .....

◆ Also available in spare parts kit 54-3605 (not furnished). Please order kit separately.

○ Available only as a 5-pack.

★ Available from Industrial Finishing distributors only.

☆ Requires 54-4370. Order separately.

## FLUID NOZZLES STANDARD FLUID NOZZLES

FLUID	FLUID NOZZLE NO.	APPLICABLE AIR NOZZLE	FLUID NEEDLE
ULTRA LIGHT / Reduced Flow	89 (.020" Dia.) 0.5 mm	90P*** 95P, 97P, 92P*, 95AP, 97AP** 93P*, 94P	SEE NOTE  54-3941/ 54-3940
VERY LIGHT / Reduced Flow	90 (.030" Dia.) 0.8 mm		
LIGHT: less than 15 to 20 seconds in a Zahn 2 Cup, e.g., stains, varnishes, thin lacquers, automotive refinishing fluids.	91 (.040" Dia.) 1.0 mm		
	92 (.046" Dia.) 1.2 mm		
MEDIUM: 20 to 60 seconds in a ZAHN 2 Cup, e.g., general industrial coatings.	93 (.051" Dia.) 1.3 mm		
	94 (.055" Dia.) 1.4 mm		
	95 (.059" Dia.) 1.5 mm		
HEAVY: greater than 60 seconds in a Zahn 2 Cup.	96 (.063" Dia.) 1.6 mm		
	97 (.070" Dia.) 1.7 mm		

**NOTE:** Use stainless steel Fluid Needle (54-3941) for all above nozzles. Optional nylon-tipped stainless steel Fluid Needle (54-3940) is also available.

## GS FLUID NOZZLES

FLUID	FLUID NOZZLE NO.	APPLICABLE AIR NOZZLE	FLUID NEEDLE
LIGHT/MEDIUM: less than 15 to 20 seconds in a Zahn 2 Cup, e.g., stains, varnishes, thin lacquers, automotive refinishing materials.	92GS (.046" Dia.) 1.2 mm	96G■	SEE NOTE  54-4547
	94GS (.055" Dia.) 1.4 mm		
MEDIUM: 20 to 60 seconds in a ZAHN 2 Cup, e.g., general industrial coatings.	96GS (.063" Dia.) 1.6 mm		

**NOTE:** Optimum setup for clear coat spray is 92GS Fluid Nozzle x 96G Air Nozzle Assembly.

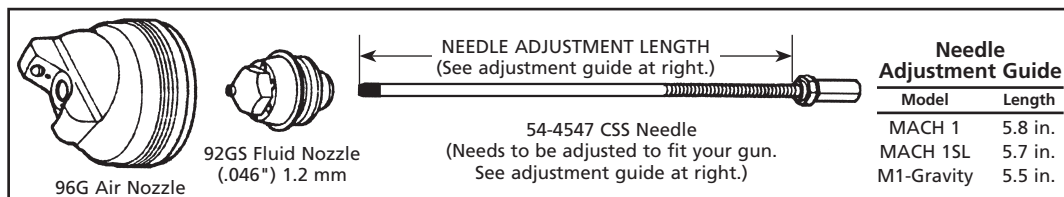

### OPTIONAL GS FLUID NOZZLE SIZES

Nozzle	Diameter	
	Inches	mm
92GS	.046	1.2
94GS	.055	1.4
96GS	.063	1.6

*Example:* 94GS Fluid Nozzle, 96G Air Nozzle & 54-4547 Needle.

## SPECIAL PURPOSE NOZZLES

TYPICAL APPLICATION	FLUID NOZZLE NO.	APPLICABLE AIR NOZZLE	COMPATIBLE FLUID NEEDLE
<b>VERY HEAVY FLUIDS:</b> Block Fillers, Texture Coatings, Fire Retardants, Road Marking Paint, Bitumastics, Adhesives, Cellular Plastics, Underbody & Vitreous Coatings, Special Applications	94VT (.052") 1.3mm Carbide Tip	94P, 97P	54-3950
	903 (.079") 2.0 mm	905P▲	54-3941/54-3940
	905 (.089") 2.3 mm		54-3941/54-3940
	905VT (.088") 2.3 mm Carbide Tip		54-3952
	906 (.100") 2.5 mm▲		54-3941/59-3940
	909 (.111") 2.8 mm		54-3941/54-3940
	909VT (.112") 2.8 mm Carbide Tip		54-3953
<b>FEATHERING</b> For applications requiring more gradual fluid valve opening for metering control of fluid flow with trigger	91F (.040") 1.0 mm	95P, 97P	54-4023
	92F (.046") 1.2 mm	92P, 93P*	54-4024
	94F (.055") 1.4 mm	95AP**●	54-4026
	97F (.070") 1.7 mm	97AP**●	54-4029
<b>SIPHON FEED-FINE FINISH</b> Light to medium fluids Auto body spot repairs Medium to heavy fluids Auto body overall finishing	94s (.055") 1.4 mm	95AS●	54-4026
	97s (.070") 1.7 mm		54-4029

\* 93P Low Volume Nozzle for automotive fine finish.  
92P Low Volume Nozzle for general industrial.

\*\* 95AP High Solids Nozzle for hard to atomize coatings and higher flow rates.  
97AP Same as 95AP, but for wider fan if needed.

\*\*\* 90P Low Volume Nozzle, 1 1/2 H.P. Compressor or bigger – (6 C.F.M) required.

● 95AP, 95AS and 97AP Air Nozzles do not require separate Retainer Ring.

■ Improves atomization, breaks-up high solid material easier, provides better finish at lower pressures and reduces orange-peel dramatically.  
54-4547 needle must be used in conjunction with the GS fluid nozzle and 96G air nozzle.

**AIR NOZZLES**

**AIR PRESSURE RECOMMENDATIONS**

TYPE OF FLUID	ATOMIZING PSI	FLUID PRESSURE RANGE- PSI
Primer/surfaces	3-4	1-4
Light Stains, Inks	4-5	1-5
Acrylic Enamels	6-7	2-7
Lacquers	7-8	2-8
Low VOC, Urethanes	8-10	2-10

**HVLP AIR NOZZLES 95P, 97P, 95AS, 95AP, 97AP, 905P**

NOZZLE ATOMIZING PSI	NOZZLE AIRFLOW SCFM	#6 (STANDARD) SIDE PORT CONTROL		#10 (OPTIONAL) SIDE PORT CONTROL	
		GUN INLET PSI	REGULATOR* PSI	GUN INLET PSI	REGULATOR* PSI
3	11.0	20	27	45	49
5	15.7	30	40	65	70
7	17.5	38	50	73	80
9	19.6	45	58	88	96
10	22.5	50	64	95	105

**HVLP AIR NOZZLE 90P**

Nozzle Atomizing PSI	Nozzle AIRFLOW SCFM	#6 (Standard) Side Port Control GUN INLET PSI
3	4.0	5
5	4.5	7
7	5.0	10
9	5.5	12
10	6.0	15

**HVLP AIR NOZZLES 92P**

NOZZLE ATOMIZING PSI	NOZZLE AIRFLOW SCFM	#6 (STANDARD) SIDE PORT CONTROL	
		GUN INLET PSI	REGULATOR* PSI
3	4.5	6.0	9
5	6.0	8.5	10
7	6.8	11.0	14
9	7.5	13.5	18
10	8.0	15.0	19

**HVLP AIR NOZZLE 94P**

Nozzle Atomizing PSI	Nozzle AIRFLOW SCFM	#6 (Standard) Side Port Control GUN INLET PSI
3	7	14
5	9	21
7	11	27
9	12	30
10	13	33

**HVLP AIR NOZZLE 93P**

NOZZLE ATOMIZING PSI	NOZZLE AIRFLOW SCFM	#6 (STANDARD) SIDE PORT CONTROL	
		GUN INLET PSI	REGULATOR* PSI
3	5.5	8.0	10.0
5	7.0	11.5	14.0
7	8.0	14.5	18.0
9	9.5	17.0	22.5
10	10.0	18.0	24.0

**HVLP AIR NOZZLE 96G**

NOZZLE ATOMIZING PSI	NOZZLE AIRFLOW SCFM	#6 (STANDARD) SIDE PORT CONTROL	
		GUN INLET PSI	REGULATOR* PSI
3	7.5	23.0	35.0
5	14.0	29.0	42.0
7	15.5	33.0	47.0
9	17.5	39.0	55.0
10	19.0	43.0	60.0

**\*NOTE**

Regulator pressures are based on 25' of 5/16" diameter hose in good condition without Quick-Disconnects or other restrictive fittings. Use the air nozzle test gauge accessory to confirm the atomizing/regulator pressure relationship for your actual air supply set-up.

These recommendations are for "typical" or "average" fluids, and are intended to serve as a starting point. Adjust as necessary for your specific application.

**HOW TO USE THE NOZZLE SELECTION CHART  
HVLP AIR NOZZLES**

All guns produced since December 15, 1990 have a 54-3946 fan control as standard equipment. Maximum recommended nozzle atomizing pressure is 10 psi. The 95P and 905P air nozzles are most suitable for conventional materials.

Use of very low fluid delivery rates with these nozzles will produce a narrower than normal fan pattern.

Use the 97P air nozzle for heavy bodied, high solids materials and low fluid rates

with conventional materials. High flow rates with light bodied materials may result in some minor "smoking" or fluid build-up on the face of these nozzles.

## SPRAY TECHNIQUE

The first requirement for a good resultant finish is the proper handling of the gun. The gun should be held perpendicular to the surface being covered and moved parallel with it. The stroke should be started before the trigger is pulled and the trigger should be released before the stroke is ended. This gives accurate control of the gun and fluid.

The distance between gun and surface should be 6 to 12 inches depending on fluid and atomizing pressure. The fluid deposited should always be even and wet. Lap each stroke over the preceding stroke to obtain a uniform finish.

### NOTE

To reduce overspray and obtain maximum efficiency always spray with the lowest possible atomizing air pressure.

## GENERAL SPRAY INSTRUCTIONS

To reduce overspray and obtain maximum efficiency, always spray with the lowest possible fluid/air pressure that produces an acceptable spray pattern.

Excessive atomizing air pressures can increase overspray, reduce transfer efficiency, and with some materials, result in poor finish quality from dry spray. Atomizing air pressures should not exceed 10 psi. See table on page 7, diagram on page 3 and *Regulatory Note* on page 1.

## OPERATING THE MACH 1 HVLP SPRAY GUN

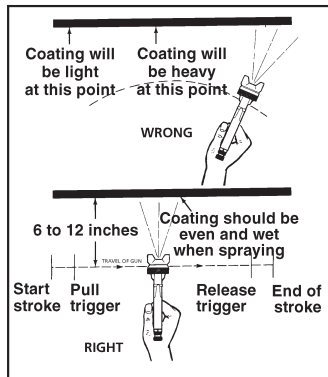

For best results, use 3 to 6 psi fluid pressure. Higher than 6 psi fluid pressure may be required for heavy-bodied materials. Low fluid pressures will produce a narrower than normal spray pattern. Generally use 30-35 psi air at gun inlet (see page 7). Unusually heavy, difficult to atomize fluids may require up to 50 psi air at gun inlet.

## CONTROLLING THE FAN SPRAY

The fan spray is controlled by means of the side port control assembly (7). Turning this control clockwise until it is closed will give a round spray; turning it counterclockwise will widen the spray into a fan shape. The fan spray can be turned anywhere through 360° by positioning the air nozzle (2) relative to the gun. To accomplish this, loosen retaining ring (1), position nozzle (2), then tighten retaining ring (1).

## CONTROLLING THE FLUID FLOW

When used with a pressure assisted cup, an increase in air pressure will increase the rate of flow. When fed from a pressure supply, an increase in the fluid pressure will increase the rate of flow. Correct fluid nozzle size should be selected for correct fluid flow rate. The fluid control knob (23) may be used to restrict the fluid nozzle (3) opening and reduce the fluid flow as necessary.

## AIR NOZZLE, FLUID NOZZLE, FLUID NEEDLE

1. All nozzles and needles are precision made. They should be handled with care.
2. Do not make any alterations in the gun. To do so could cause finishing difficulties.
3. To clean nozzles, soak them in solvent to dissolve any dried material, then blow them clean with air.

4. Do not probe any of the holes in the nozzles with metal instruments. If probing is necessary, use only a tool that is softer than brass.

## TROUBLESHOOTING

### Faulty Spray

A faulty spray pattern is often caused by improper cleaning resulting in dried materials around the fluid nozzle tip or in the air nozzle. Soak these parts in thinners to soften the dried material and remove with a brush or cloth.

### CAUTION

Never use metal instruments to clean the air or fluid nozzles. These parts are carefully machined and any damage to them will cause faulty spray.

If either the air nozzle (2) or fluid nozzle (3) are damaged, these parts must be replaced before perfect spray can be obtained.

### Intermittent Spray

If the spray flutters, it is caused by one of the following faults:

1. Insufficient fluids available. Check supply and replenish if necessary.
2. Pressure vent tube from gun body to pressure assist cup is loose or leaking.
3. Check valve in pressure vent tube is stuck or blocked.
4. Pressure assist cup cover not sufficiently tight or cover gasket defective.
5. Insufficient fluid pressure from standard pressure pots.

## AIR NOZZLE TEST GAUGE ASSEMBLY

Part Number	Description
54-3902	92P Nozzle
54-3908★	900 Series
54-3935	95, 97P, 95AP and 97AP
54-4066★	94P Nozzle
54-4078★	95AS and 97AS Nozzles (Siphon)
54-4345★	90P Nozzle
54-4356	93P Nozzle
54-4566	96G Nozzle

★ Available from Industrial Finishing distributors only.

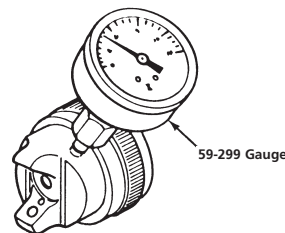

## WARRANTY

This product is covered by Binks' 1 Year Limited Warranty.

**Binks Sales and Service: [www.binks.com](http://www.binks.com)**

**BINKS**

U.S.A./Canada Customer Service  
195 Internationale Blvd.  
Glendale Heights, IL 60139  
630-237-5000

Toll Free Customer Service  
and Technical Support  
800-992-4657

Toll Free Fax  
888-246-5732

77-2463R-18 Revisions: Trademark updates.